

Varenummer: 204350M16200D1U

Beskrivelse: E+G Justerfod
GN 43-50-M16-200-D1-U

Note: U Uden møtrik, sekskant i toppen, spændeflade i bunden

Mål

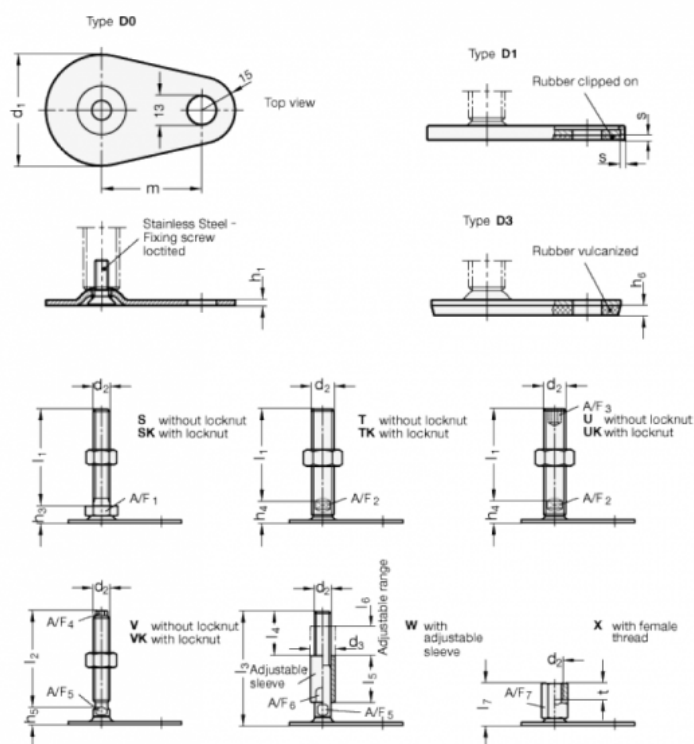

A/F2 = 12	m = 45
A/F3 = 8	s = 2
d1 = 50	
d2 = M16	
h1 = 2.5	
h4 = 17	
h6 =	
l1 = 200	